



Credit: U.S. Army/Maj. Robert Fellingham



Credit: Textron Aviation



Credit: U.S. Navy

SPACE AND DEFENSE GROUP

DEFENSE DIVISION 2024

EQUIPPING THOSE WHO DEFEND FREEDOM

MOOG

Moog at a Glance

Shaping the way our world moves™

World leader in high-performance motion control solutions for mission-critical applications

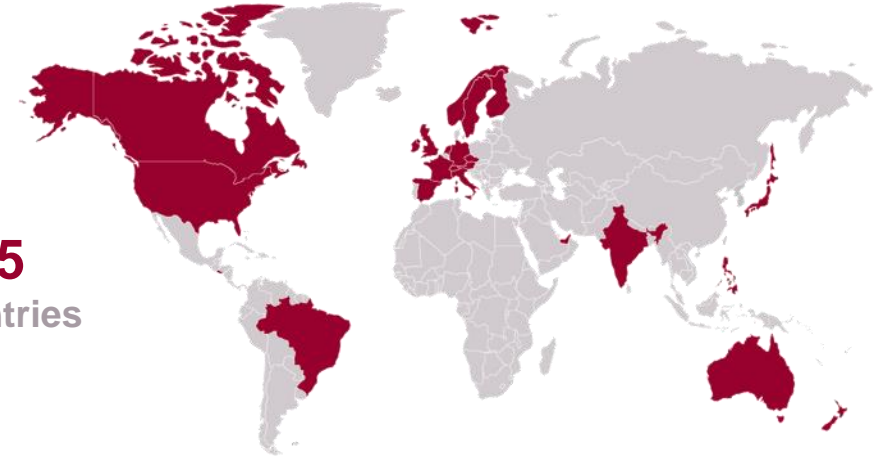

1951
Founded by Bill Moog

14,000
Employees

\$3.3 B
FY 2023 Revenue

70+ YEARS
Controls Heritage

25
Countries

FY 23 Revenue

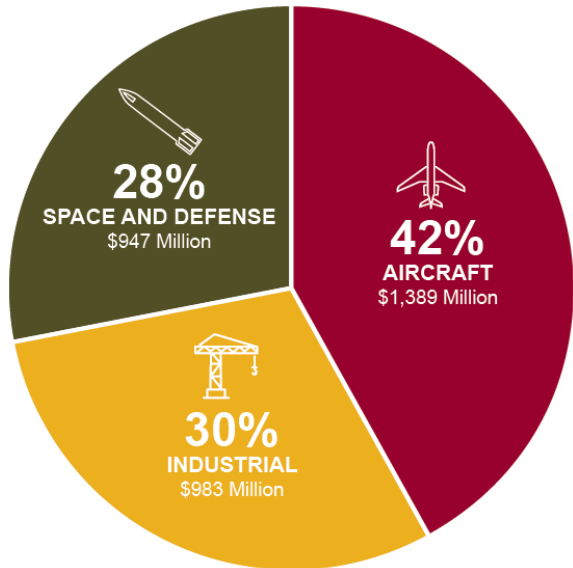

Business Segments

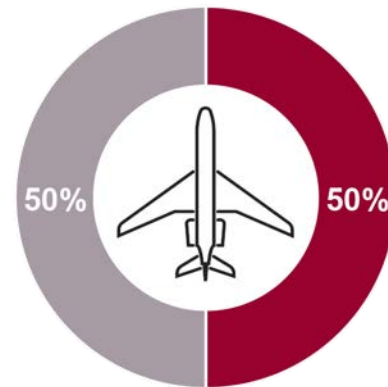

- Military Aircraft
- Commercial Aircraft

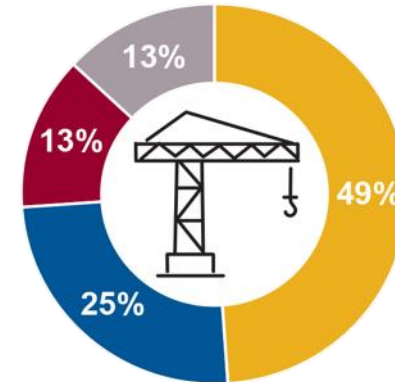

- Industrial Automation
- Medical
- Energy
- Simulation and Test

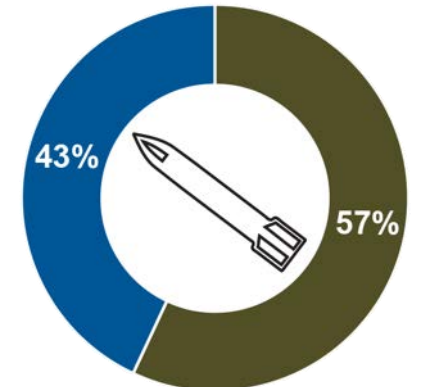

- Defense
- Space

70+ Years Supporting the Warfighter

Moog is recognized by military forces around the world for equipping those who defend freedom with multi-domain mission critical technologies.

900
Defense Employees

540M
Defense Revenue

**TOP 10
U.S. ALLIES
AND PARTNERS**
End Users of Moog
Defense Solutions



Business Segments



Agile Prime™



Defense
Control
Systems



Defense
Sustainment



Missile
Systems



Naval
Systems

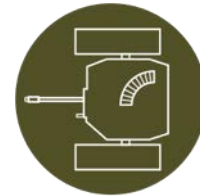

Turreted
Weapon
Systems

Providing Solutions Across Multi-Domain Platforms

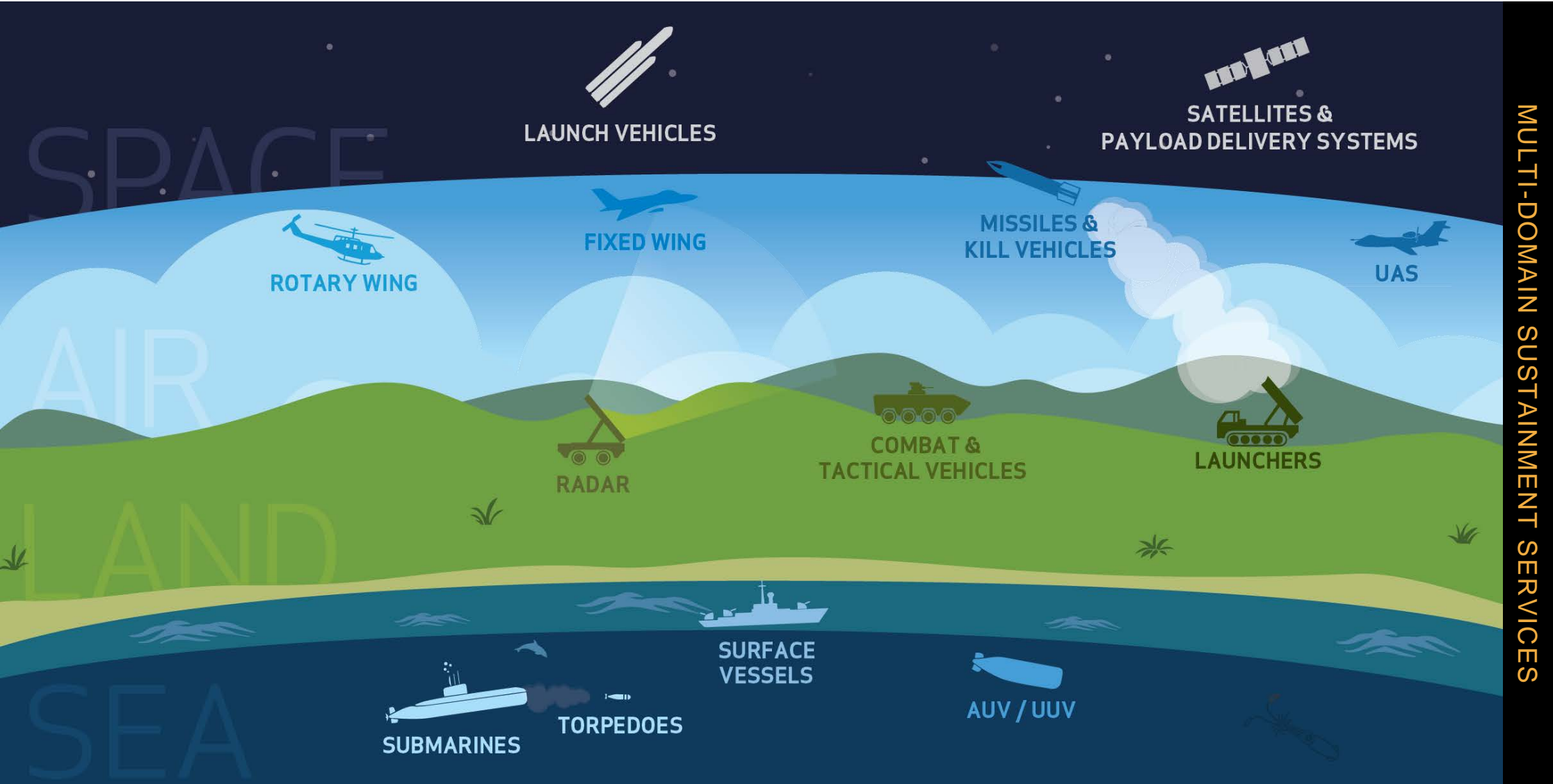

Solutions for Defense

From components to full systems and sustainment support, Moog has defense solutions to meet your mission critical needs.

AIR



LAND

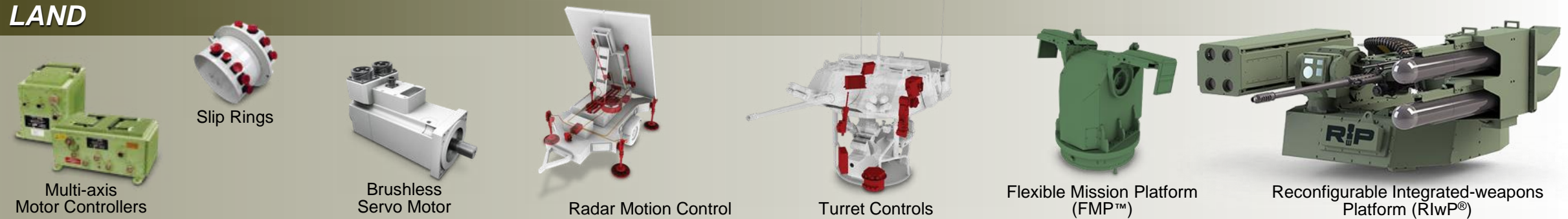

SEA

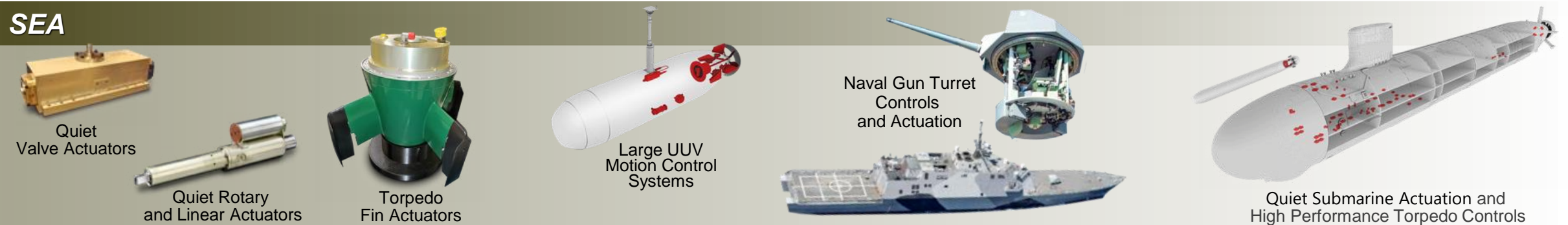

Space and Defense Group – Defense Division



Mike Gruver
Group Vice President



Greg Zyla
Business Development/Strategy



John Liddle
Operations and Supply Chain Director



Ryan Kilpatrick
Finance Business Partner



Lori Nielson
Human Resources Business Partner



Paul Rignel
Sustainment Business Unit Director



Jim York
Naval Systems Business Unit Director



Tony Peck
Turreted Weapons Systems Business Unit Director



Jason Weiss
Defense Control Systems Business Unit Director



Beth Spiess
Missile Systems Business Unit Director

Defense – Air Solutions



- Missile steering, control actuation systems, thrust vector control, seeker motors, guidance, and navigation & control
- Divert, attitude, and roll control thrusters
- Gun turret control systems
- Weapon stores management systems
- Helicopter de-ice system slip rings
- EO/IR target acquisition components
- Airborne military surveillance radar systems

Credit: U.S. Air Force

Notable Air Applications and Programs



PrecISR *Credit: Hensoldt*



HELLFIRE®



**Common-Hypersonic
Glide Body (C-HGB)** *Credit: Maxal Tamor*



Black Hawk *Credit: U.S. Army*



AC-130J Ghost rider *Credit: U.S. Air Force*



THAAD *Credit: U.S. MDA*



MD530F+

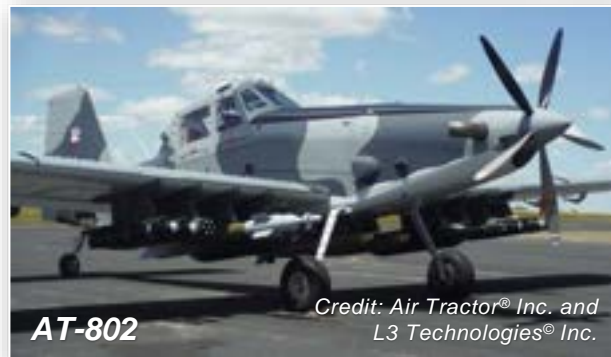

AT-802 *Credit: Air Tractor® Inc. and L3 Technologies® Inc.*



Scorpion Jet *Credit: Textron Aviation*

Defense – Land Solutions



- Turreted weapons systems
- Mission systems integration
- Stabilized motion control for turrets, launchers, and radar systems
- Remote weapon operation and fire control
- Air defense and counter-UAS
- Complex defense automation
- Conversions and upgrades
- Weapon stores management systems



Notable Land Applications and Programs



Defense – Sea

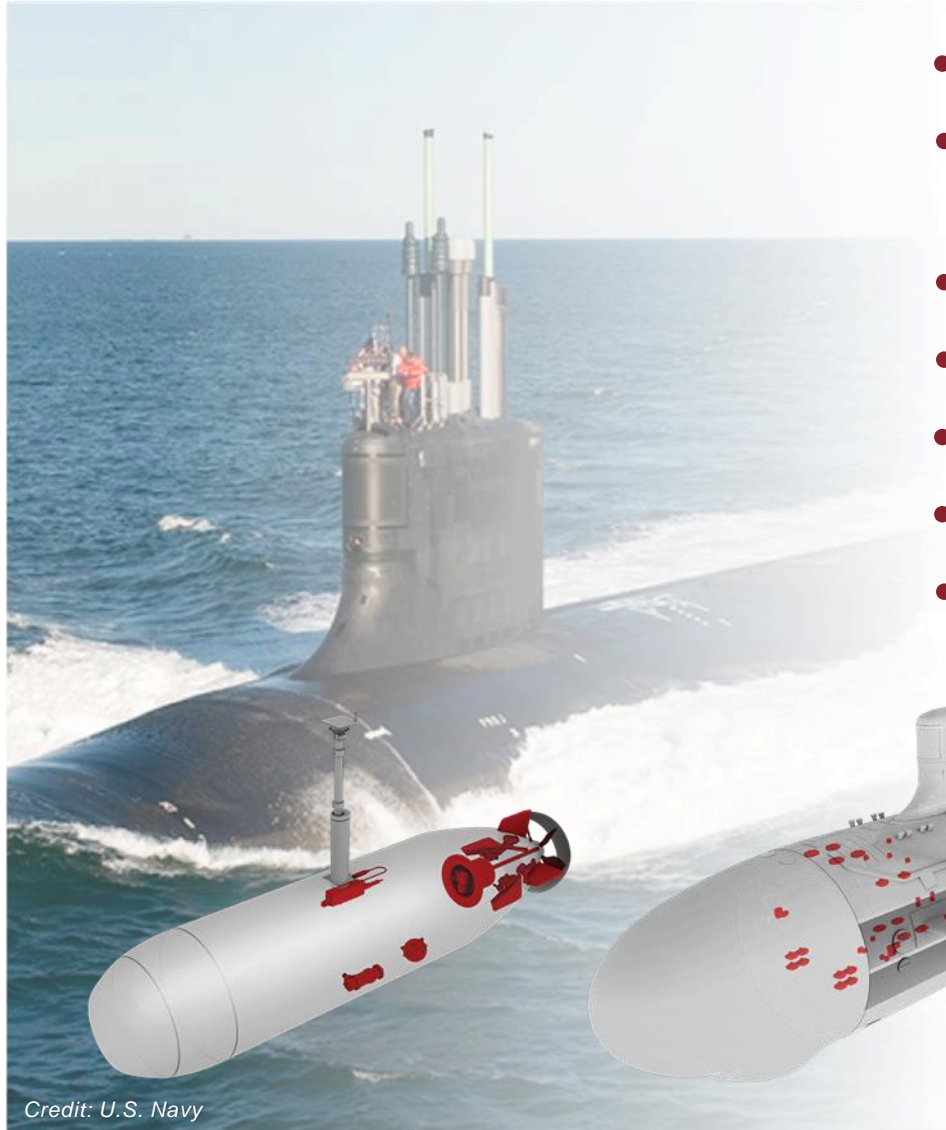

- Submarine quiet actuation
- Unmanned undersea vehicle (UUV) quiet propulsion and actuation
- UUV launch and recover
- Surface ship turret motion control and stabilization
- Torpedo fin actuation systems
- Weapon stores management systems
- EO/IR, radar and turret system components



Credit: U.S. Navy

Notable Sea Applications and Programs



Moog Total Support for Defense



Sustainment offerings

- OEM product support
- Modernization and upgrades
- Field service and support
- Simulation and training
- Engineered solutions

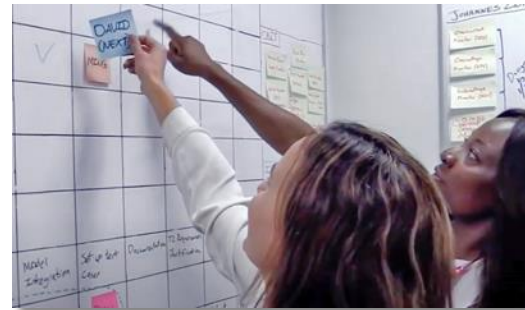

Moog Differentiators



Trusted Partner

INTEGRITY: The quality of being honest and having strong moral principles

At Moog, we believe that integrity is a choice. We abide by consistently high ethical standards. With steadfast resolve, we are equipping those who defend freedom.



Social and Environmental Responsibility



We believe in doing the right thing.

Moog's values are rooted in trust, respect, integrity, and collaboration. They lay the foundation for Moog's commitment to Corporate Social and Environmental Responsibility.

It is crucial we do our part to improve the world for current and future generations by recognizing and celebrating our differences.

Diversity, Equity and Inclusion at Moog

By recognizing and celebrating our differences, we cultivate an environment that's the right fit for every person inside of it. Moog is a place where employees are empowered to bring their whole, authentic selves to work every day.



800+
Employees
Engaged in
Employee
Resource Groups

7
Active Employee
Resource
Groups

11,000+
Employees
took Conscious
Inclusion
Training

2023
Honored with
Society of Women
Engineers (SWE)
Mission Award

Employee Resource Groups

- Black Employee Support Team (US)
- India Women's Group
- Moog Veterans Organization (US)
- Pride at Moog (Global)
- Women and Allies at Moog (US)
- Women's Resource and Equity Network (UK)
- Working Caregivers Group



*Credit: U.S. Army National Guard/
Sgt. Brad Mincey*



*Credit: U.S. Navy/Mass communication Specialist
2nd Class Brett McMinoway*



Credit: U.S. Army



*Credit: U.S. Navy/Chief Mass Communication Specialist
Kathryn E. Macdonald*



*Credit: U.S. Air Force/
Airman 1st Class Monica Roybal*



Credit: U.S. Marine Corps/Cpl. Yvonna Guyette



*Credit: U.S. Marine Corps/
Lance Cpl. Jaime Reyes*



*Credit: U.S. Navy/Mass Communication Specialist 2nd Class
Aaron T. Smith*

The appearance of U.S. Department of Defense (DoD) visual information does not imply or constitute DoD endorsement.

REV 03/24